

I enlarged view

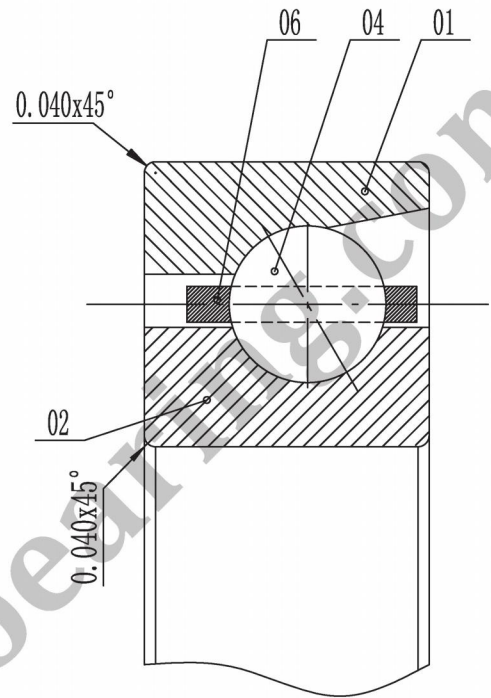

KAYDON THIN SECTION BEARING

Formal drawing of SB042AR0 will be submitted after contact with:
sales@jcb-bearing.com or sales@thinsectionbearings.com

06	cage		nylon			
04	steel ball		AISI 440C stainless steel balls			
02	inner ring	1	AISI 440C stainless steel balls			
01	outer ring	1	AISI 440C stainless steel balls			

No.	designation	qty	material	unit	total	remark
					weight (lbs)	

Luoyang JCB Bearing Technology Co., Ltd
 Contact information
 Company Address : No.285 Fenghua road, Luoyang, Henan,China.
 Postal code : 471000
 Phone : 0086-379-68611678 Fax : 0086-379-68611679
 E-mail: sales@jcb-bearing.com
 Reserved E-mail: sales@thinsectionbearings.com
 Website: <http://www.jcb-bearing.com>
<https://www.thinsectionbearings.com>

SB042AR0

weight(lbs)

0.31

total page 1

page 1

Luoyang JCB Bearing Technology Co., Ltd